

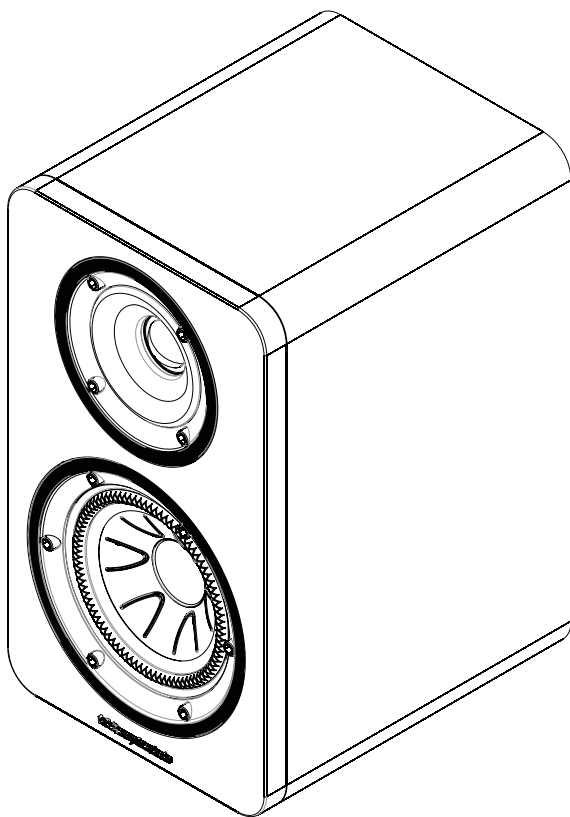

# DIAMOND ACTIVE SERIES

Diamond A1  
Diamond A2



*Wharfedale*

User's Manual



## IMPORTANT SAFETY INFORMATION



This symbol indicates that there are important operating and maintenance instructions in the literature accompanying this unit.



This symbol indicates that dangerous voltage constituting a risk of electric shock is present within this unit.

**WARNING: TO REDUCE THE RISK OF FIRE OF ELECTRIC SHOCK, DO NOT EXPOSE THIS APPARATUS TO RAIN OR MOISTURE.**

Read these instructions.

Keep these instructions.

Heed all warnings.

Follow all instructions.

Do not use this apparatus near water.

Clean only with cloth.

Do not block any ventilation openings.

Install in accordance with the manufacturer's instructions.

Do not install near any heat sources such as radiators, heat registers, stoves, or other apparatus (including amplifiers) that produce heat.

Do not defeat the safety purpose of the polarised or grounding plug. A polarised plug has two blades with one wider than the other. A grounding plug has two blades and a third grounding prong. The wide blade or the third prong is provided for your safety. If the provided plug does not fit into your outlet, consult an electrician for replacement of the obsolete outlet.

Protect the power cord from being walked on or pinched particularly at plugs, convenience receptacles, and the point where they exit from the apparatus.

Only use attachments/accessories specified by the manufacturer.



Use only with the cart, stand, tripod, bracket, or table specified by the manufacturer, or sold with the apparatus. When a cart or rack is used, use caution when moving the cart/apparatus

combination to avoid injury from tip-over.

Unplug the apparatus during lightning storms or when unused for long periods of time.

Refer all servicing to qualified personnel. Servicing is required when the apparatus has been damaged in any way, such as power supply cord or plug is damaged, liquid has been exposed to rain or moisture, does not operate normally, or has been dropped.

**CAUTION:** These servicing instructions are for use by qualified service personnel only. To reduce the risk of electric shock, do not perform any servicing other than that contained in the operating instructions unless you are qualified to do so.

**WARNING:** To reduce the risk of fire or electric shock, do not expose this apparatus to rain or moisture. The apparatus shall not be exposed to dripping or splashing and that objects filled with liquids, such as vases, shall not be placed on apparatus.

**WARNING:** The mains plug/appliance coupler is used as disconnect device shall remain readily operable.

No naked flame sources, such as lighted candles, should be placed on the apparatus.

**DO NOT** place heavy objects on top of loudspeaker cabinets. If you play them with the grilles removed be careful to protect the drive units from children and pets.

**DO NOT** change any connections to the subwoofer or your system without first switching off the power.

**DO NOT** use your amplifier or receiver at its maximum volume setting. This will produce high levels of distortion which may damage your loudspeakers and subwoofer. Allow your amplifier a little headroom so that it can operate without stress.

**DO** turn down the volume control on your amplifier or receiver before turning the equipment on or off. This will protect your subwoofer against switching 'thumps' and other spurious signals.



**WEEE**

Correct disposal of this products. This marking indicates that this product should not be disposed with other household wastes throughout the EU. To prevent possible harm to the environment or human health from uncontrolled waste disposal, recycle it responsibly to promote the sustainable reuse of material resources. To return your used device, please use the return and collection systems or contact the retailer where the product was purchased. They can take this product for environmentally safe recycling.



This equipment is a Class II or double insulated electrical appliance. It has been designed in such a way that it does not require a safety connection to electrical earth.

## Introduction

For over 30 years, The Wharfedale Diamond Series has been the go-to speaker for entry level, high-fidelity sound. Praised for articulated performance at an affordable price, Diamond 200 series has won multiple awards, with What Hi-Fi? Sound and Vision commenting on its sound quality as "Agile, far-reaching dynamics; overflowing with detail" (Diamond 220 - March 2015).

With such a rich history of high performance combined with affordability, Wharfedale proudly present Diamond Active Series. The Diamond A1 is a bookshelf two-way speaker, and the A2, a floorstanding 2.5 way speaker. The new wireless speakers incorporate everything music fans love about Diamond series into an easy to use package, equipped to cater for a wealth of audio sources with an innovative approach to wireless technology.

## How It Works

Unlike other wireless and active speakers where controls and inputs are often placed awkwardly on the back panel, Wharfedale engineers have developed a unique hub, which works as the central console for your music.

The Diamond H1 Hub features Optical, Coaxial and RCA inputs on the rear panel with an additional Bluetooth aptX connection for wireless integration of laptops, smart phones and tablet devices. It's controlled gracefully via the touch sensitive display, or for even more convenience you can use the included remote.

Once connected to your source, the Hub works independently from the speakers using the 5.8GHz wireless frequency band. Place it on your TV stand, desktop, or wherever you want, without the worry of speaker placement and trailing wires in-between the units. The only wires needed for the speakers are the supplied power cables.



The Diamond A1 speakers and H1 Hub work wirelessly, completely independently of each other with no interconnects.



The units communicate between each other on the 5.8GHz frequency band for high quality, lossless playback.



Change source / volume and menu parameters with the included remote.

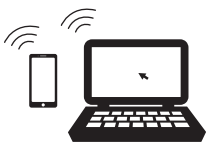

Connect any Bluetooth device and enjoy wireless playback with the aptX codec for CD-like sound quality.

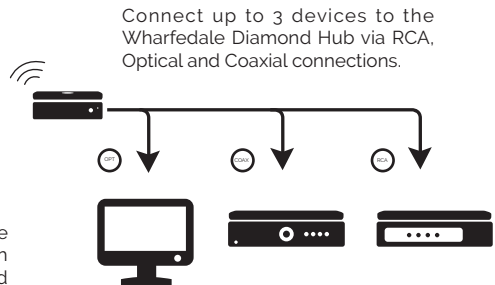

## Unpacking & Setup

Carefully unpack each speaker. If you are unpacking the Diamond A2 speaker, please remember that these units are heavy. We suggest that you have someone to assist you.

Lift the loudspeaker carefully out of the packing. DO NOT try and lift the loudspeaker using the protective bag. Remember to unpack the accessories carefully.

If there is any sign of damage or if the contents are incomplete, report this to your dealer as soon as possible.

Retain all the packing materials so that your speaker can be repacked and shipped without damage. If you dispose of the packing, do so with regard to all recycling provisions in your area.

The speakers are set to operate for the mains voltage marked on the amplifier panel. Before connecting check that this voltage is correct for your mains supply.

If you move to an area with a different mains supply voltage, please consult your Wharfedale dealer to arrange the conversion of this product.

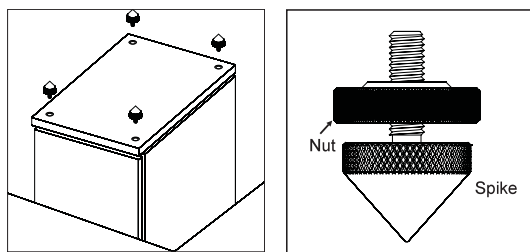

When attaching the spikes to the A2 floorstanding model, make sure you have plenty of unobstructed working space. Place a cloth on the floor to protect the loudspeaker and invert the loudspeaker onto the cloth. Thread a locknut onto each spike and loosely rub it up the thread. Thread the spikes into the spike inserts and then tighten them finger tight. Once screwed in, invert the loudspeaker and be careful not to damage the floor with the spikes.

When the speakers are upright you may find the speaker will wobble with one spike not contacting the floor. To correct this adjust the spikes until all are in contact with the floor.

For the Diamond A1, small rubber feet are supplied with an adhesive layer on the front side. Stick these to the bottom of each A1 speaker so the leatherette material is not damaged or worn from table top surfaces or speaker stands.

## Please note

The Diamond A1 system is sold in 2 boxes:

1. Diamond A1 speakers (pair boxed together)
2. Diamond H1 Hub

The Diamond A2 system is sold in 3 boxes:

1. 2 x Diamond A2 speakers (boxed individually)
2. Diamond H1 Hub

If you are missing any of these items please contact your authorised Wharfedale retailer or distributor before unpacking or setting up any part of the system.

## Installation: Diamond A1 & Diamond A2 Speakers

The operation of both the Diamond A1 and A2 speakers is exactly the same.

- Plug each Diamond Active speaker in to the mains power supply and turn on the power switch to enter start up mode.
- The LED will then flash green, slowly. This means the speakers have not connected to any Wharfedale H1 Hub device – you will need to pair the speakers with a hub (followed in Installation: Hub section). After pairing, the LED light will turn green and not flash. After pairing for the first time you will not need to do this again when turning off and on the system again.
- Use the Left/Mono/Right switch to set the speakers stereo output. You can either select the left/right options accordingly if using a conventional stereo setup. Alternatively if you are placing the speakers around the room or living area in an unconventional way, you can set the speakers both to mono if you wish
- The -6dB/0/6dB switch attenuates the bass levels of the speakers. You can use this to adjust the sound to your personal preference, and may find the bass will need reducing when placed near to a wall.
- The update port is only used for updating the internal software. Generally the user will not need to operate this, we suggest to refer to the Wharfedale website or your Wharfedale dealer concerning updates.
- The pair button connects the Wharfedale speakers as one system (short press). If you long press the button until the LED indicator flashes then the software version will be displayed on the H1 Hub screen.

## Installation: H1 Hub

- Connect any devices you want to hear via the Auxiliary, Optical or Coaxial inputs on the rear panel.
- Connect the H1 Hub mains supply. The H1 Hub indicator light will then turn on, which means it is now in standby mode.
- The H1 Hub uses touch sensitive controls. Either touch the on/off button on the unit, or press the on/off button on the remote control and the standby LED will turn off. The screen will then briefly display the Wharfedale logo, confirming the unit is working. To return to standby, press the on/off button once more.
- If the display of the H1 Hub reads 'Not Connected' you will need to match a pair of speakers to the H1 Hub.
- Press the 'Menu' button on the remote (or long press the source button on the unit), then press 'OK' (or 'source' button on the unit), then the right control on the remote (or the '+' button on the unit) to enter pairing mode. Then press 'OK' (or source button once more) to confirm pairing operation. The screen will then display 'Searching'.
- Then press the pair button on the A1 or A2 speakers you are using and you will see 'Finished' displayed on the H1 Hub screen. The Diamond A1 or A2 speakers' LED will then light up green, confirming the connection.
- Please note pairing speakers needs to be done individually, so once your first speaker is paired, repeat the process for the second speaker.
- To adjust the volume, press the '+' and '-' buttons accordingly on the H1 Hub or remote. The default volume is 12, with a maximum of 42.
- To change the source, press the source select button (rounded rectangle with arrow icon). The H1 Hub has four channels to select: Bluetooth, Auxiliary, Optical and Coaxial.
- When selecting Bluetooth, the H1 Hub will display 'Pairing', which means the H1 Hub is not yet connected to a Bluetooth device and is searching for one.
- To connect, make sure your Bluetooth device is turned on and search for active Bluetooth devices. You will then see Diamond A as an option to connect. Select pair to device and the H1 Hub will then display 'Connected' to confirm.
- If you switch to an alternative input Bluetooth will disconnect automatically in 10 seconds, however when you switch back, Bluetooth will connect automatically to your device once more.



## Menu: H1 Hub

- To access additional controls over the Diamond Active system either press 'Menu' on your remote or long-press the source button.
- This will give you different options: Speakers, Balance, Brightness, Display Delay, Auto Standby, Factory Reset and Firmware.
- You can toggle through the different options by pressing the '+' or '-' controls or left and right controls on the remote.
- The source button toggles between menu select and the menu parameter, or you can press the up / down button on the remote.
- When you have selected a parameter to adjust, press the '+' or '-' buttons on the H1 Hub or remote
- Balance: This alters the balance between the left and right speakers. Once the desired balance is set press the 'Balance Sync' button on the rear of the Diamond A1 or Diamond A2 for the changes to take effect.
- Display Delay: This function adjusts how long the display is on after adjusting the controls the options are: Always on, 1 minute, 30 seconds (default) and 15 seconds.
- Auto Standby: You can adjust the auto-standby function to always on (default) or 20 minutes, where it will auto-switch to standby if there has been no signal for 20 minutes.
- Factory Reset: This function will restore the system to its factory default settings. Select 'Yes/No' to confirm.
- Firmware: This function displays the firmware version of your system. Generally the user will not need to operate this, we suggest to refer to the Wharfedale website or your Wharfedale dealer concerning updates.



## Rear Panel & Control Diagrams

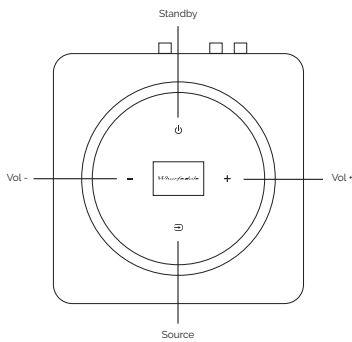
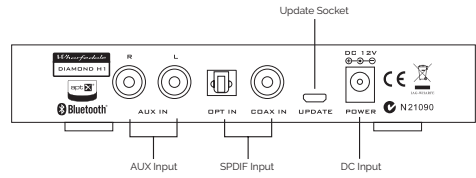
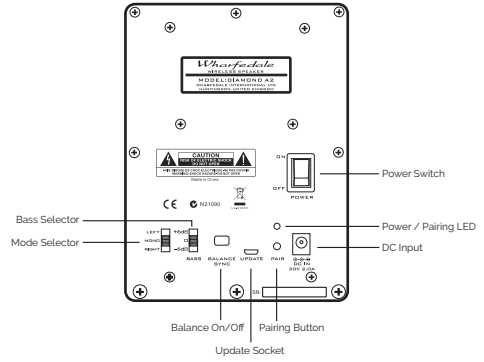
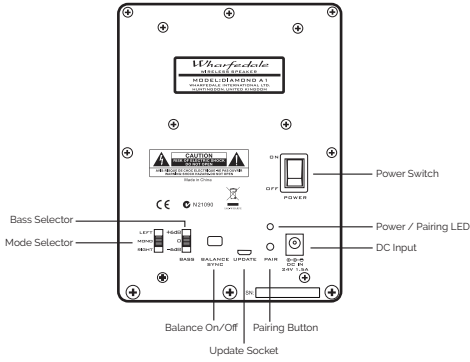

## USER INSTRUCTIONS: Diamond Active Series

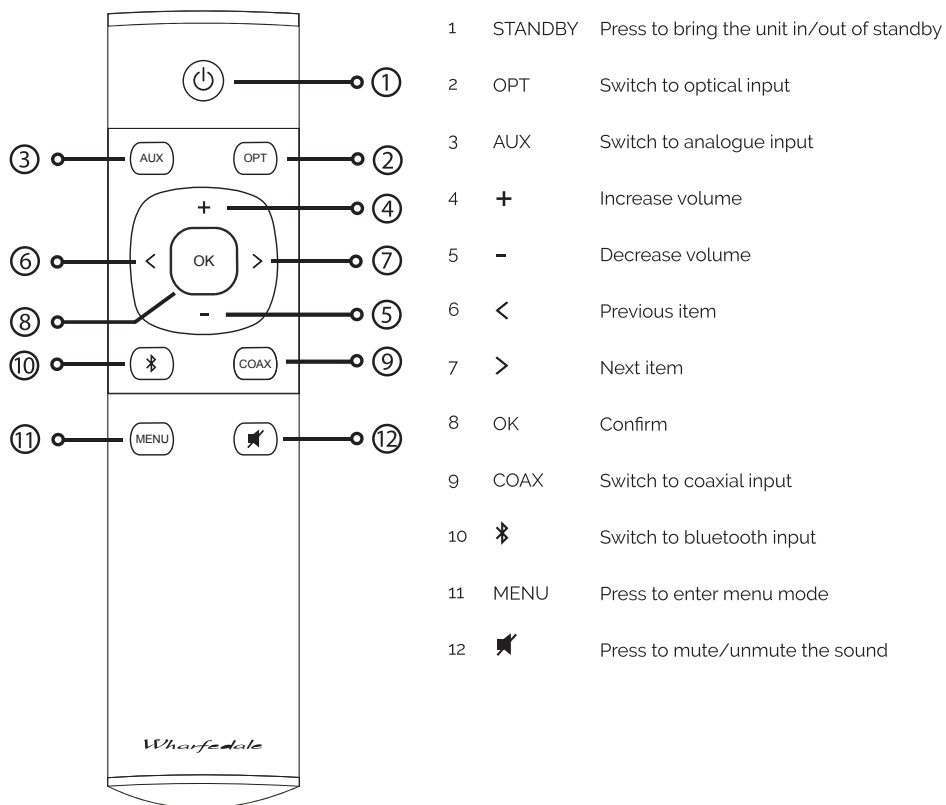



## Specifications

Model	Diamond A1	Diamond A2
Design philosophy and core technology	5.8GHz wireless uncompressed technology +/- 6dB Bass Control Balance Function Mode selector: Left/Mono/Right Digital Amplifier with DSP	5.8GHz wireless uncompressed technology +/- 6dB Bass Control Balance Function Mode selector: Left/Mono/Right Digital Amplifier with DSP
Digital Input	1 x Coaxial, 1 x Toslink Optical	1 x Coaxial, 1 x Toslink Optical
Analog Input	RCA x 2	RCA x 2
Bluetooth Input	aptX (Priority), SBC	aptX (Priority), SBC
Input sensitivity	350mV	350mV
Signal frequencies	5.8GHz wireless uncompressed	5.8GHz wireless uncompressed
Sampling rate for digital Wireless	Up to 24bit / 96kHz	Up to 24bit / 96kHz
reception distance	20m	20m
Enclosure type	bass reflex	bass reflex
Transducer complement	2-way	2.5-way
Rated power output	30W	50W
Peak power output	60W	100W
Peak SPL	95dB	96dB
Frequency response (+/-3dB)	55Hz - 20KHz	40Hz - 20KHz
Bass extension (-6dB)	50Hz	35Hz
Crossover frequency	2.3KHz	2.8kHz
Speaker Finish	Black Leatherette with High Gloss White / Black Front Baffle	Black Leatherette with High Gloss White / Black Front Baffle
Hub Finish	High Gloss Black with Touch Sensitive Display	High Gloss Black with Touch Sensitive Display
Speaker Dimensions & Weight (each)		
Cabinet Volume	7.6L	38L
Height (on feet)	(315*6)mm	(912*25)mm
Width	186mm	210mm
Depth	(220*10)mm	(300*10)mm
Net Weight	5.5kg	18.8 Kg
Hub Dimensions & Weight		
Height	28.8mm	28.8mm
Width	150mm	150mm
Depth	156mm	156mm
Net weight	0.46kg	0.46kg



## USER INSTRUCTIONS: Diamond Active Series

---

### Service

Should a fault occur with your Diamond Active system please pack it correctly using the original packing so it can be shipped safely. Product for service should be returned to the appointed dealer from whom you purchased the product. If you experience difficulties or if there is no W/harfedale dealer in your area, contact the W/harfedale distributor for your country (listed at [www.wharfedale.co.uk](http://www.wharfedale.co.uk)) or the office below.

IAG House, 13/14 Glebe Road,

Huntingdon, Cambridgeshire,

PE29 7DL UK

Tel: +44 (0)1480 452561

Fax: +44 (0)1480 413403





---

USER INSTRUCTIONS: Diamond Active Series





*Wharfedale*

IAG House, 13/14 Glebe Road, Huntingdon, Cambridgeshire, PE29 7DL, UK  
Tel: +44(0)1480 452561 Fax: +44(0)1480 413403 [www.wharfedale.co.uk](http://www.wharfedale.co.uk)  
IAG reserves the right to alter the design and specifications without notice. All rights reserved © IAG Group Ltd.  
Wharfedale is a member of the International Audio Group. CODE: WH14-MNL006a

